

TYPE L075HAK (hæl)

Dimensioner

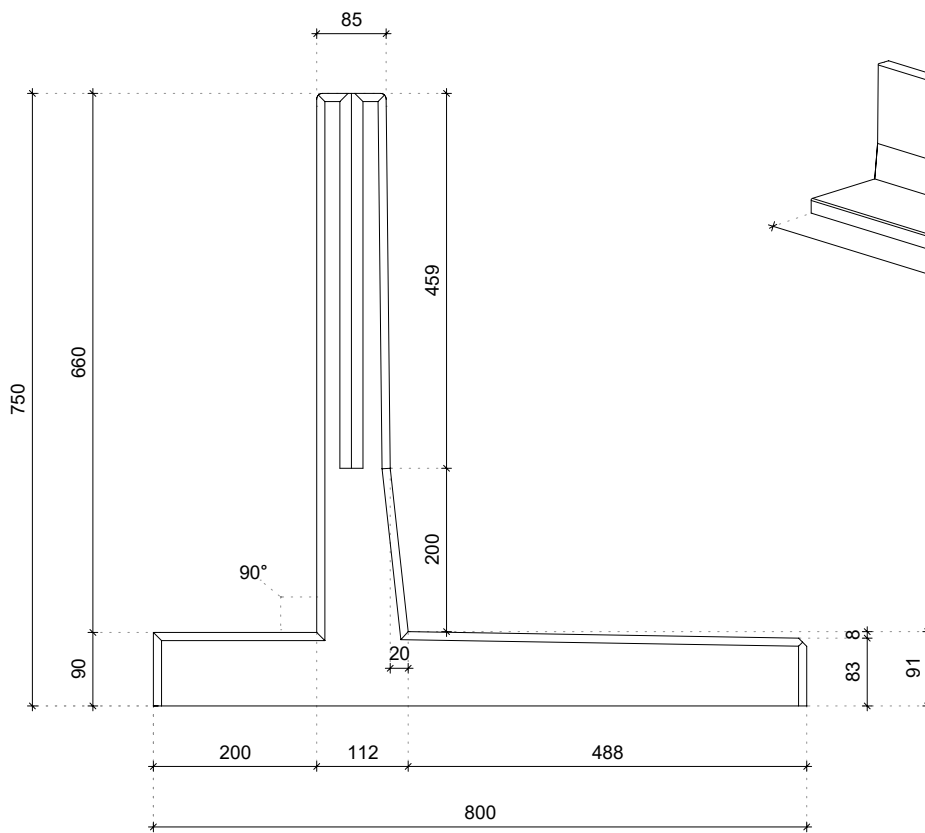

Detaljer

Afrundet top

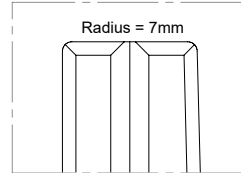

Udskæring til samlings liste

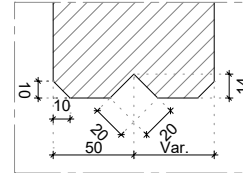

Element samling

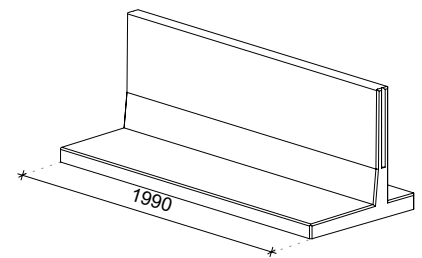
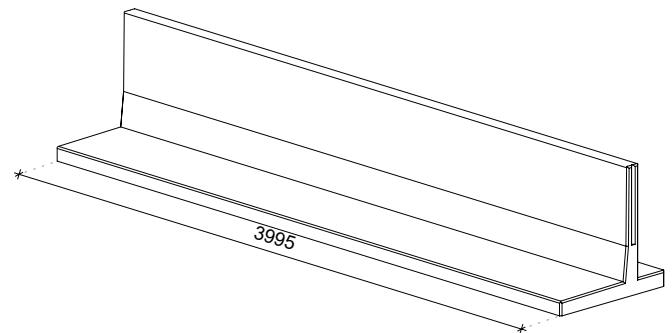
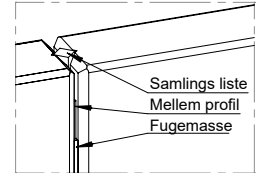

Tekniske detaljer

Betonblanding	3 rd generation self-compacting C55/67
Armering af stål	B500
Vægt	1220kg (L = 3995mm) / 610kg (L = 1990mm)
Betondækning	30mm
Dimensionel tolerance	+/- 5mm
Synlig betonklasse	Alle synlighed sider klasse A
Design liv	50 år
Produktgaranti	10 år
Miljøklasse	XA3, XC4, XD3, XS3, XF4
Højseanordning	ingen, steder med klemme

Konstrueret i overensstemmelse med

DS-EN 1990 Eurocode 0	DS-EN 206
DS-EN 1991 Eurocode 1	Incl. nationale bilag
DS-EN 1992 Eurocode 2	
DS-EN 1997 Eurocode 7	

Produktionsmetode



Energi
neutral



Filterret
regnvand



Bæredygtige
råvarer



Genanvendelige
materialer

Certifier

