

# TYPE L300

## Dimensioner

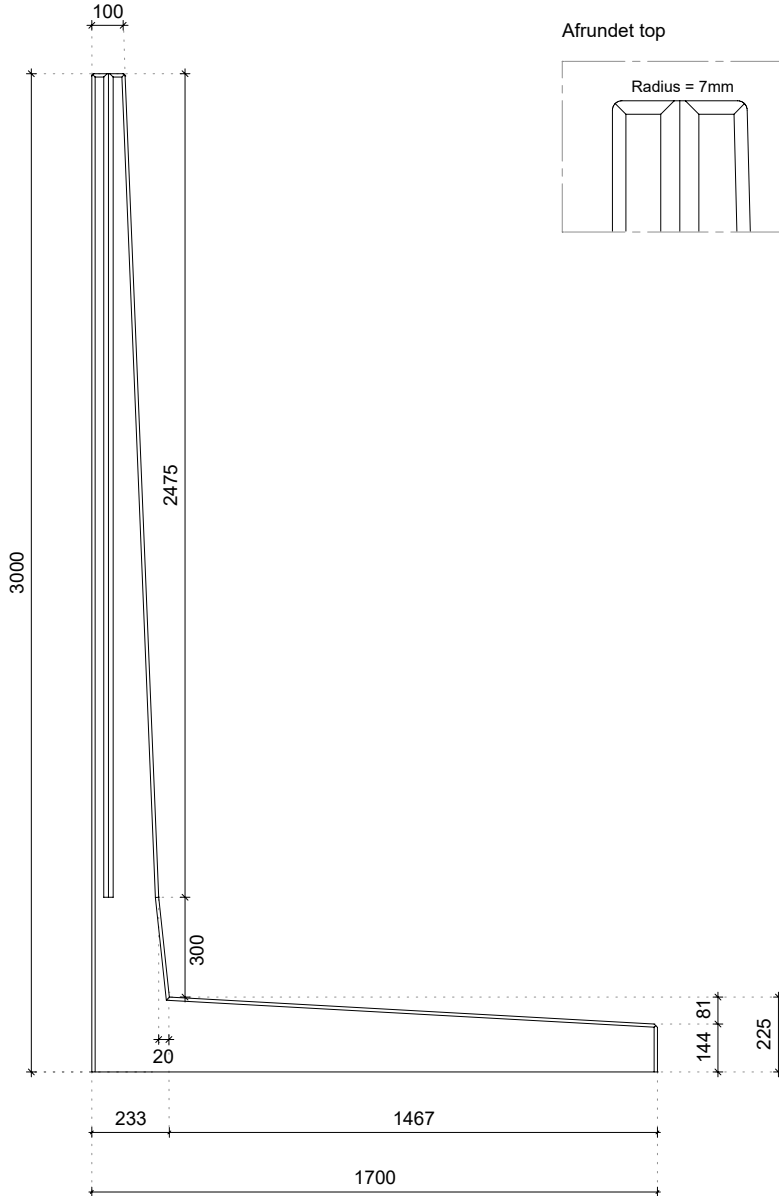

## Detaljer

### Afrundet top

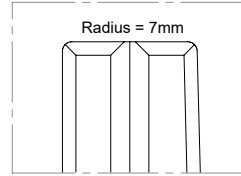

### Udskæring til samlings liste

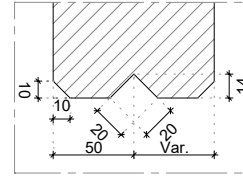

### Element samling

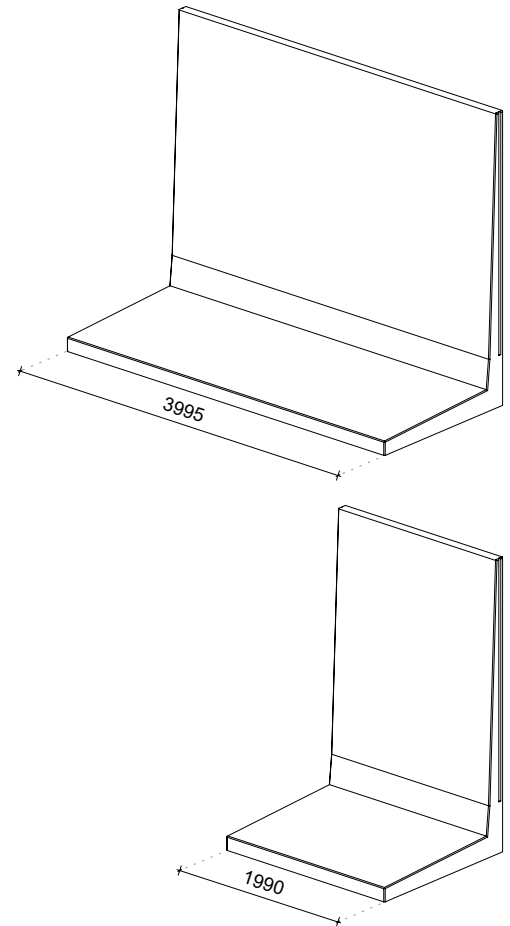
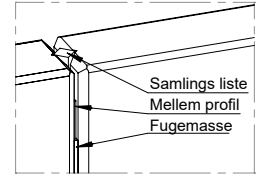

## Tekniske detaljer

Betonblanding	3 <sup>rd</sup> generation self-compacting C55/67
Armering af stål	B500
Vægt	7390kg (L = 3995mm) / 3645kg (L = 1990mm)
Betondækning	30mm
Dimensionel tolerance	+/- 5mm
Synlig betonklasse	Alle synlighed sider klasse A
Design liv	50 år
Produktgaranti	10 år
Miljøklasse	XA3, XC4, XD3, XS3, XF4
Højseanordning	ingen, steder med klemme

## Konstrueret i overensstemmelse med

DS-EN 1990 Eurocode 0	DS-EN 206
DS-EN 1991 Eurocode 1	Incl. nationale bilag
DS-EN 1992 Eurocode 2	
DS-EN 1997 Eurocode 7	

## Produktionsmetode



Energi  
neutral



Filterret  
regnvand



Bæredygtige  
råvarer



Genanvendelige  
materialer

## Certifier

